

## Microcontroller

The Pro Micros form the hearts of each half of the keyboard. The left and right halves each have a different pinout.

You may of course also use Pro Micro compatible controllers, such as the Elite-C or Nice!Nano.

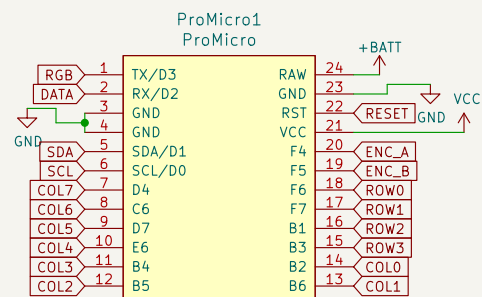

Left

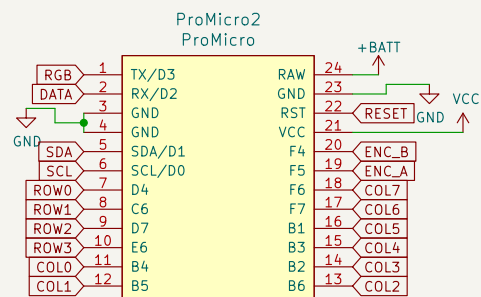

Right

The two resistors R1 and R2 need to be soldered on both halves. If you choose to use I2C across halves, R1 and R2 only need to be soldered on one half.

They are required for proper I2C operation.

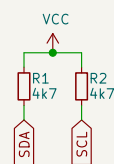

The reset button allows you to flash new firmware to the keyboard. For most changes, it's only necessary to flash the side you use as master. Some changes, like those to underglow and the OLED display, do need to be flashed to both sides.

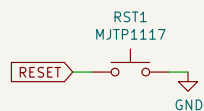

Header for SSD1306 (or compatible) OLED display

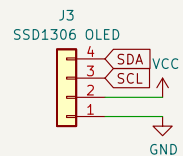

Battery header and power switch for Nice!Nano users

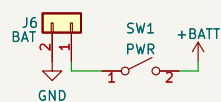

A TRRS cable connects both halves of the keyboard. Do not unplug when turned on.

By default, serial is used across halves. This enables the use of one OLED screen per keyboard half. If you require I2C across halves (and thus give up using two OLED displays), you may cut the JP1 jumper and solder wires from the SDA and SCL pins of the Pro Micro or I2C breakout to the R1 and R2 pads respectively.

The R1 pad may also be used to pass data from an RGB LED strip through to the other side. It cannot be used for I2C that way.

Take care not to confuse the TRRS's R1/R2 pads with the resistors R1/R2.

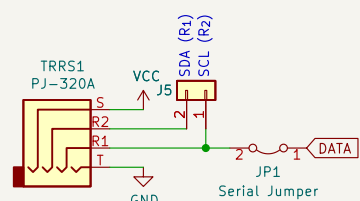

## Switch matrix

The matrix allows for two 2u keys to be used in place of the 1u keys on the outer end of the thumb cluster, taking up the MXa21 and MXa22 positions. The innermost thumb cluster key or the top/bottom pinky key can be replaced with a rotary encoder. If the encoder has a button, that button takes the place of MX25 / MX6 / MX20.

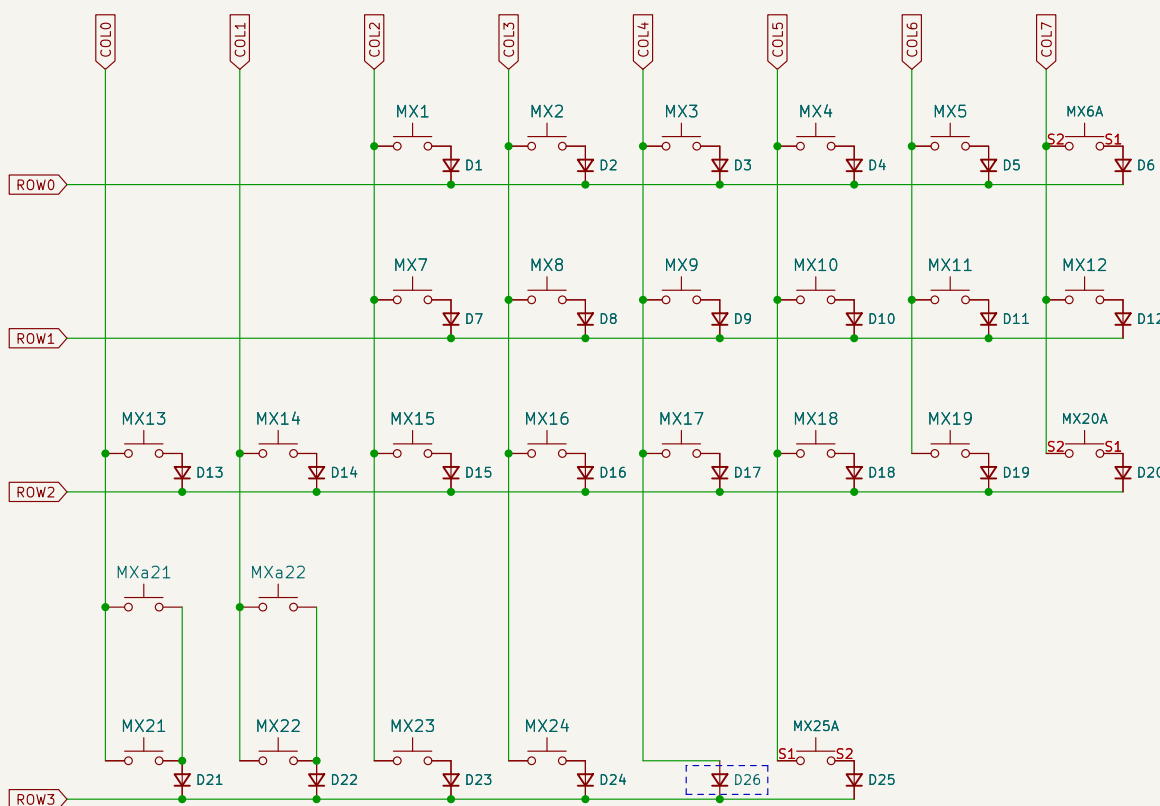

D26 is only present on the left half. It is used by QMK to auto-detect which half it is running on. Do not solder it when using ZMK, as it will prevent your nice!nano from entering deep sleep.

## Encoders

The use of a rotary encoder is optional. An EC11 encoder or compatible may be used. When you don't use an encoder, the B5 and C6 pins become available for use in modifications.

Note that the MX7B encoder shares the same physical position as the MX7A switch. Only one encoder may be installed per half.

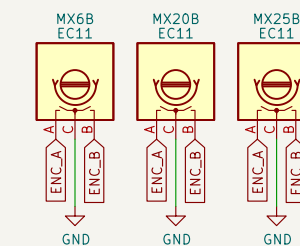

## Board edge breakouts

Rows and columns are broken out. This allows you to add extra buttons at the empty spots in the matrix to the left.

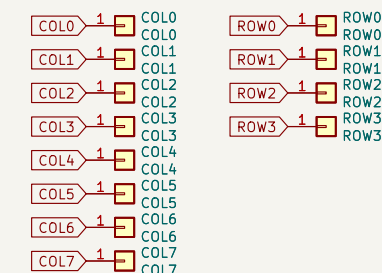

I2C pins are broken out for easy access when adding modifications that use the I2C protocol.

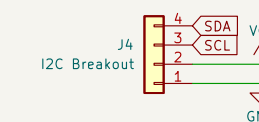

When using a WS2812B or compatible LED strip, you can use these pins to easily form a connection. The B5 and D0 pins are accessible for modding when you choose not to use a rotary encoder.

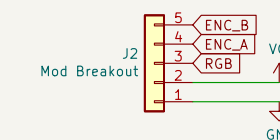

An ICSP header is available for reflashing the bootloader. You likely won't need this.

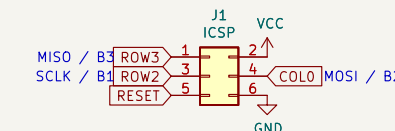

## RGB Underglow

RGB LEDs are optional and may be installed using either individual WS2812B LEDs (or compatible), or a WS2812B LED strip (or compatible).

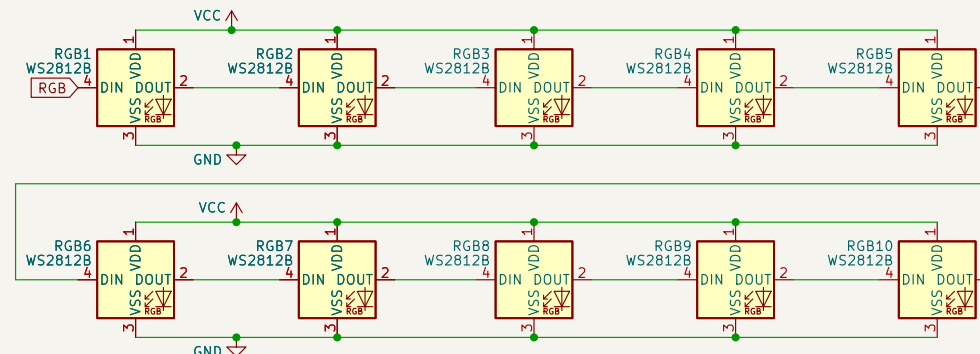

For build instructions, please visit [splitkb.com](http://splitkb.com).

[splitkb.com](http://splitkb.com)

Sheet: /  
File: public\_schematics.kicad\_sch

**Title: Kyria**

Size: A3 Date: 2022-09-06

Rev: 2.1  
Id: 1/1