

Microcontroller

The Pro Micros form the hearts of each half of the keyboard. The left and right halves each have a different pinout.

You may of course also use Pro Micro compatible controllers, such as the Liatris, Elite-C, or niceNano.

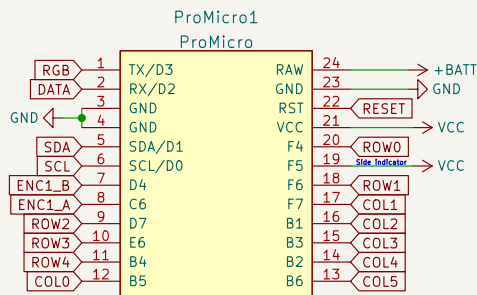

Left

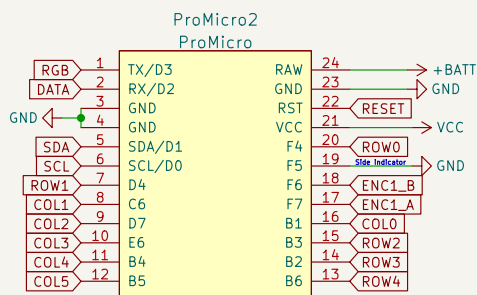

Right

The two resistors R1 and R2 should normally be soldered on both halves. If you choose to use I2C across halves, R1 and R2 only need to be soldered on one half.

They are required for proper I2C operation.

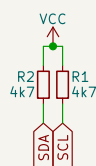

A TRS or TRRS cable connects both halves of the keyboard. Do not unplug when turned on.

By default, serial is used across halves. This enables the use of one OLED screen per keyboard half. If you require I2C across halves (and thus give up using two OLED displays), you may cut the JP1 jumper and solder wires from the SDA and SCL pins of the Pro Micro or I2C breakout to the R1 and R2 pins respectively - marked Ra and Rb on the PCB.

The R2 pin may also be used to pass extra data through to the other side. If R2 is used, you must use a TRRS cable.

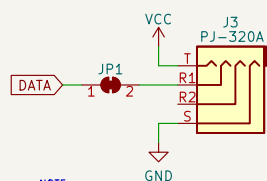

NOTE: On revision 1.0, the labels for JP1 and JP2 were accidentally swapped. This does not impact functionality.

Battery header and power switch for niceNano users

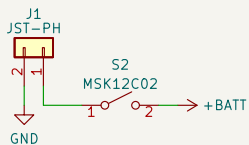

Switch matrix

The top/bottom pinky column keys, inner thumb key, or key underneath the controller can be replaced with a rotary encoder. If the encoder has a button, that button takes the place of SW1 / SW20 / SW26 / SW19 in the matrix.

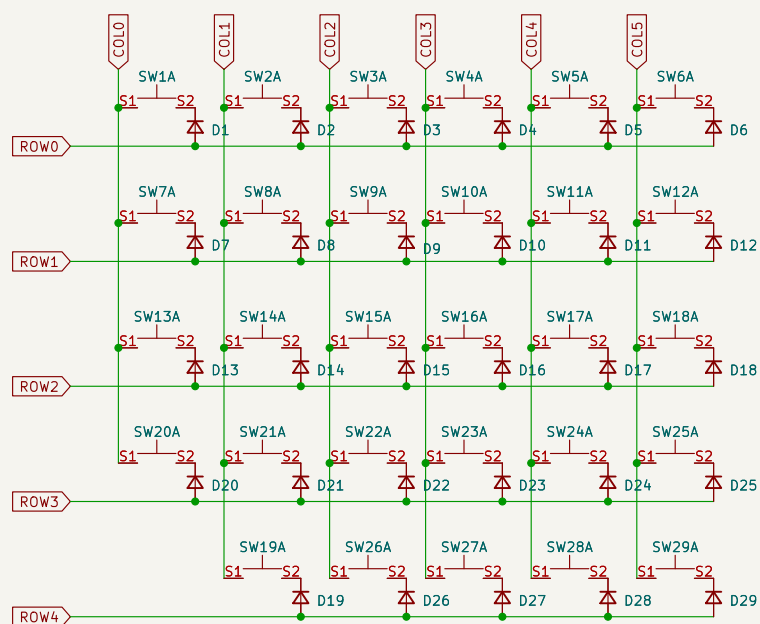

NOTE: On revision 1.0, D27 and D29 were accidentally swapped. This does not impact functionality.

Encoders

The use of a rotary encoder is optional. An EC11 encoder or compatible may be used. When you don't use an encoder, the encoder pins become available for use in modifications.

Note that the SW7C encoder shares the same physical position as the SW7A switch.

Only one encoder may be installed per half.

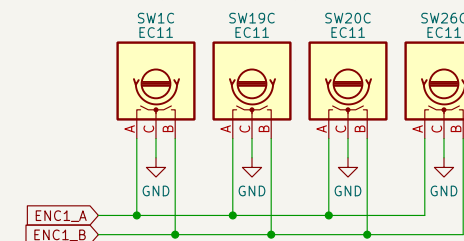

Per-key RGB

Per-key RGB LEDs are optional and may be installed using SK6812MINI-E LEDs (or compatible).

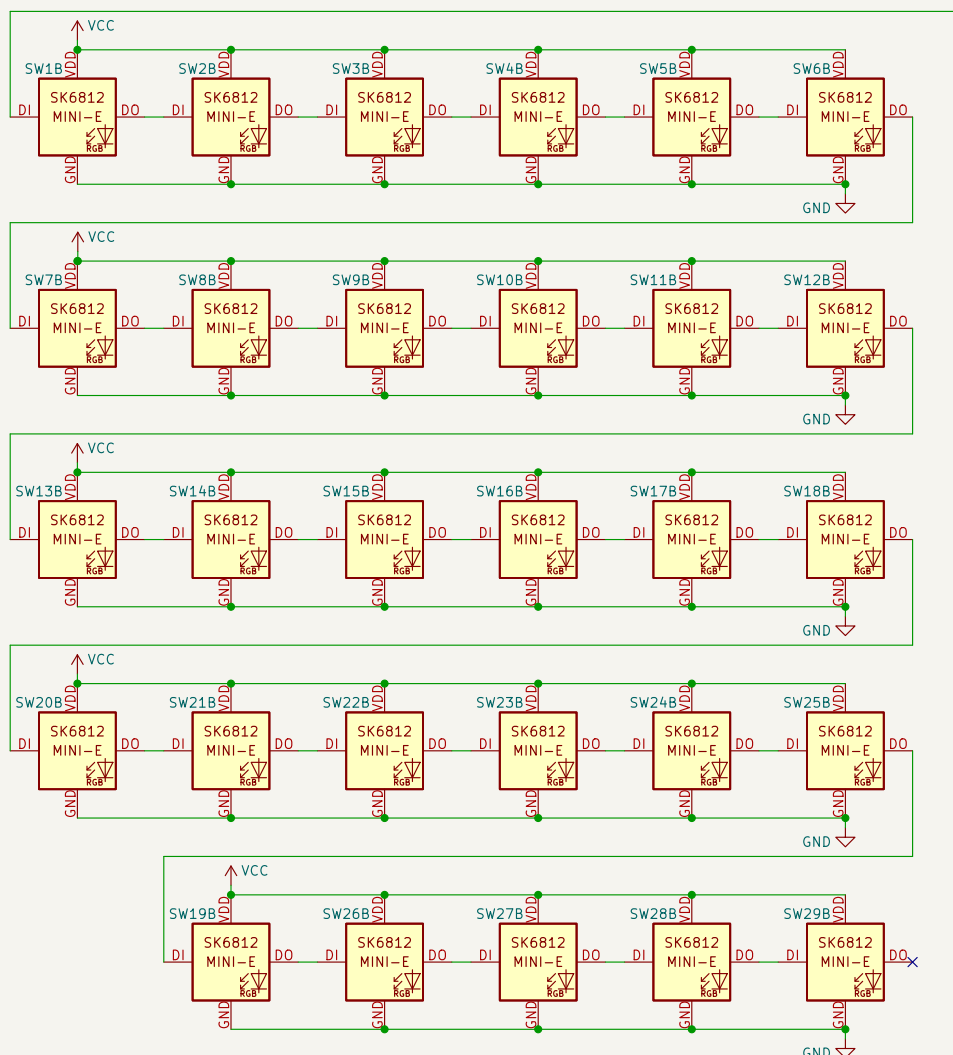

RGB Underglow

RGB underglow LEDs are optional and may be installed using WS2812B LEDs (or compatible).

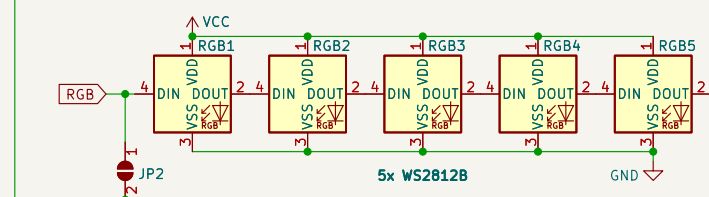

Underglow bypass

Solder jumper JP2 closed if you are using per-key rgb without rgb underglow.

NOTE: On revision 1.0, the labels for JP1 and JP2 were accidentally swapped. This does not impact functionality.

The reset button allows you to flash new firmware to the keyboard. For most changes, it's only necessary to flash the side you use as master. Some changes, like those to underglow and the OLED display, do need to be flashed to both sides

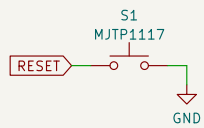

Header for SSD1306 (or compatible) OLED display

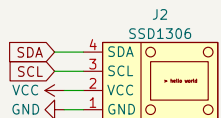

splitkb.com

Sheet: /
File: aurora_lily58.kicad_sch

Title: Aurora Lily58

Size: A3 Date: 2022-12-12
KiCad E.D.A. eeschema 6.0.7

Rev: 1.0
Id: 1/1